

CIJ Printer PB Series

for Industrial Marking

HITACHI

Inspire the Next

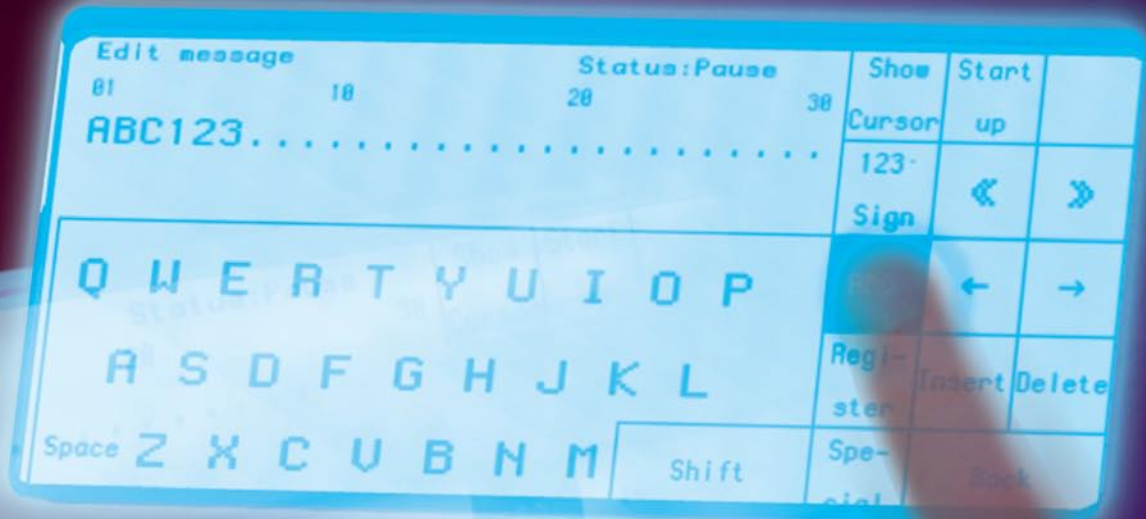

- Easy and quick operation by large liquid crystal display and 8.9" touch panel
- Full protection against dust and water jets (IP45, test specification IEC60529:2001)
- Viscosity control and current ink density control for stable drop formation and high quality printing
- Improved ink circulation system for stable ink return and reduced solvent evaporation
- Nozzle and Gutter are automatically cleaned before stopping
- Various printing and coding functions
- Operating temperature 0–45 °C (JP-K69 ink)
- Global Standards: CE, C-Tick

CIJ Printer PB Series

for Industrial Marking

HITACHI
Inspire the Next

All features at a glance

Model	PB-260E
Nozzle size	65 µm
Max. print line number	Up to 2 Lines
Max. number of print characters (each line)	1 Line: Up to 80 characters 2 Line: Up to 40 characters
Dot matrix (horizontal x vertical)	1-2 Line: 5 x 8 (or 5 x 7), 7 x 10; 12 x 16
Character height	1 Line: 2-4 mm / 2 Line: Total height: 4.5-8mm
Display & input device	Display: Liquid crystal display (8.9 inch, monochrome), back-light provided Input Device: Touch panel, input sound provided
Display language	German, English, French, Italian, Spanish, Portuguese, Dutch, Swedish, Arabic, Greek, Russian, Czech
Maximum print rate	Up to 821 character/s (font 5 x 7, space 1, 1 line)
Standard characters	Alphanumeric (A-Z, a-z, 0-9), symbols (27), Space: total 90
Number of user pattern registration	Each dot matrix 40 characters
Print functions	Calendar, counting, data storage (48 data), bold (2 times), product speed matching, repeat print, etc.
Input signal	Print object detection, rotary encoder pulse
Output signal	Print ready, fault, warning (open collector signal)

General specifications	
Printhead cable length	3m
Power supply (Automatic Voltage selection)	AC 100-120 / 220-240V ±10% · 50/60 Hz 150VA
Cabinet	Stainless Steel/IP45
Approval	CE, C-Tick
Operating temperature range	0-45 °C (JP-K69 Ink)
Humidity Range	30-90% R.H.* (no condensation)
Overall size (width x depth x height)	400 x 290 x 515 mm
Approximate weight	25 kg

* Note: When humidity is more than 85% RH, please purge inside of print head by dry and clean air.
Information in this brochure is subject to change without notice.

PB Series Dimensions of Console and Printhead

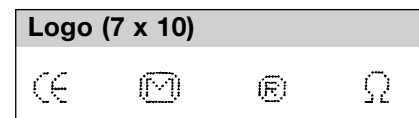
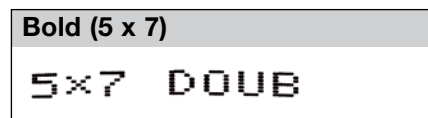
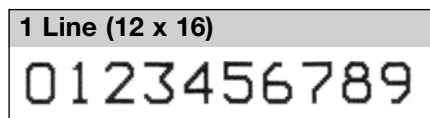
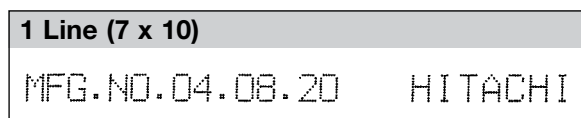
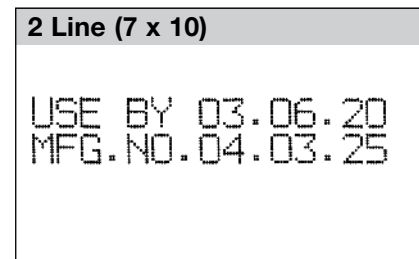
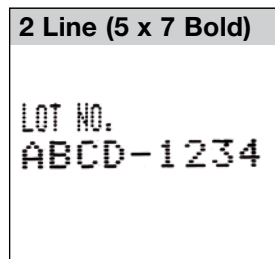
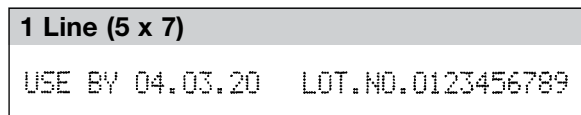
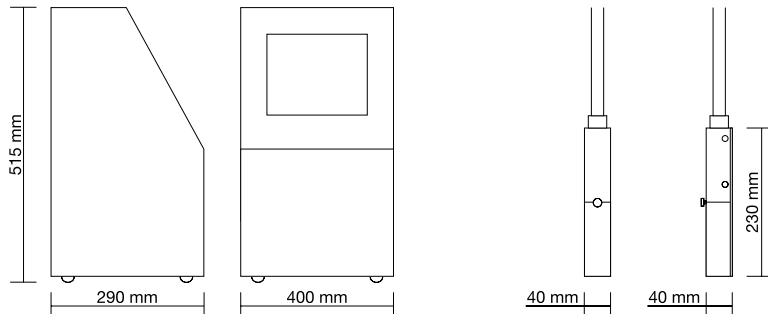

Hitachi Europe GmbH
Am Seestern 18 · D-40547 Düsseldorf
Tel. +49-211-52 83 -0 · Fax +49-211-52 83 -649
Internet: www.hitachi-ds.com
E-Mail: info@hitachi-ds.com

